

happy

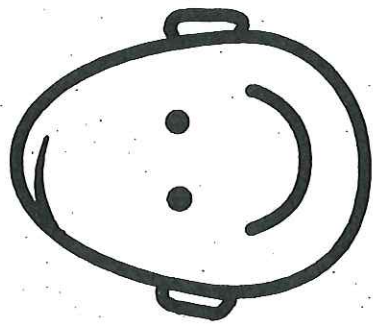

don't know

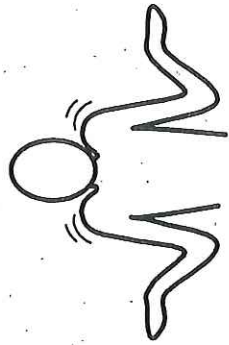

tired

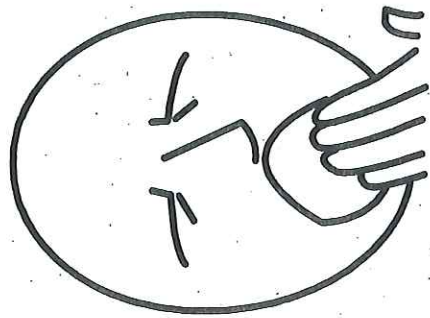

angry

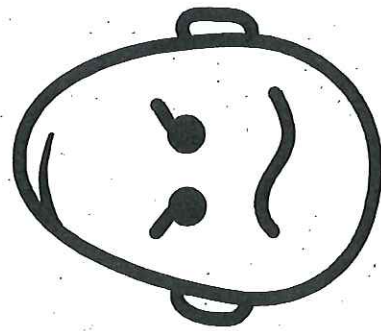

not well

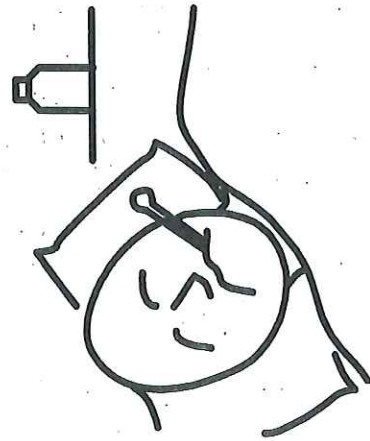

sad

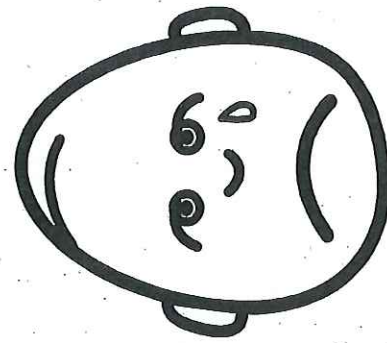

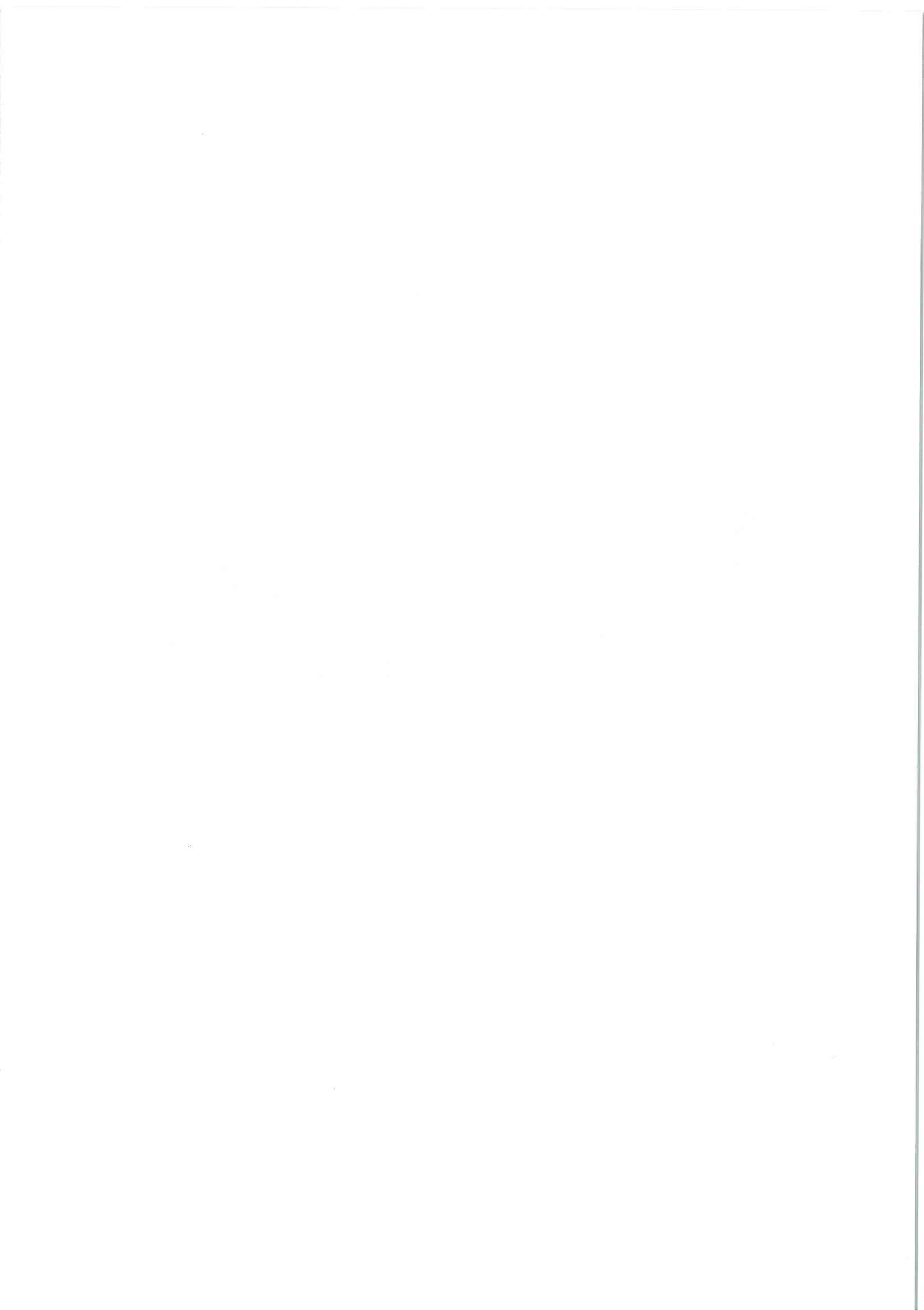

Ten in the bed

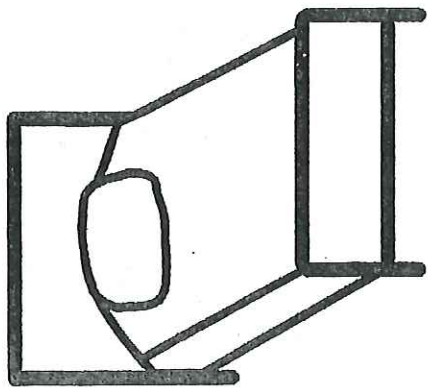

1 2 3 4 5

6 7 8 9 10

Five Little Monkeys



Five bears sitting on the wall

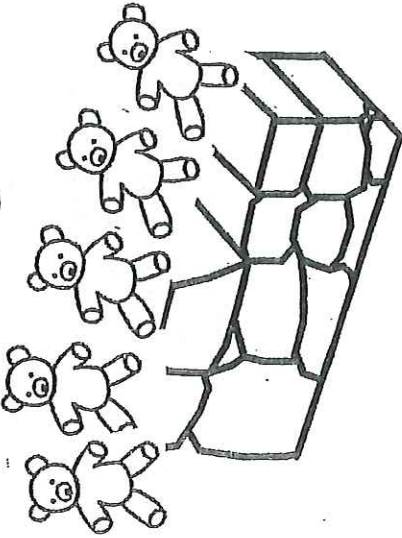

Five little ducks

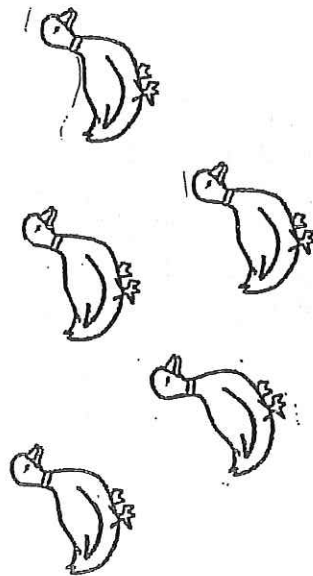

Five little frogs

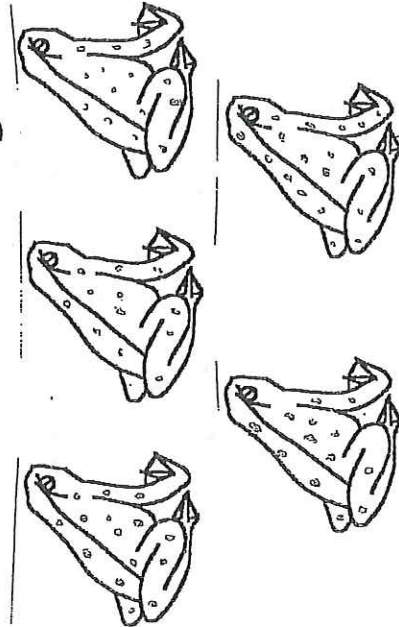

Pizza Hut

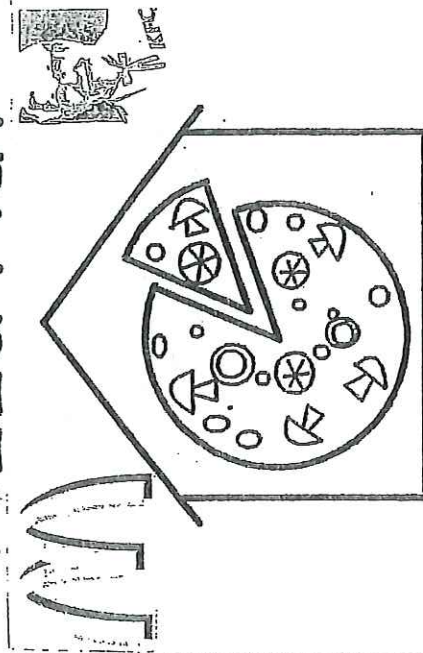

Five little bears
Sitting on the wall
Five little teddy bears
Sitting on the wall
And if one little bear
Should accidentally fall
There'd be four, three, two,
one, no little bears sitting on
the wall.

Five little monkeys
Swinging in the tree
Teasing Mr. Crocodile
"You can't catch me, you
can't catch me".
Along came Mr. Crocodile
As quiet as can be
And SNAP
He took a little monkey home
To have some tea.

There were ten in the bed
And the little one said
"Roll over, roll over"
So they all rolled over
And one fell out.
There were 9, 8, 7, 6, 5, 4, 3, 2, 1
In the bed
Then there were none in the
bed
And the little one said

A Pizza Hut
A Pizza Hut
Kentucky Fried Chicken and a
Pizza Hut
Macconalds, Macconalds
Kentucky Fried Chicken
And a Pizza Hut

Five little speckled frogs
Sat on a speckled log
Eating the most delicious
grubs
Yum, Yum
One jumped into the pool
Where it was nice and cool
Then there were four green
speckled frogs
GLUB GLUB.
4, 3, 2, 1 little speckled
frogs
etc. etc.

Five little ducks
Went swimming one day
Over pond/hills and faraway
Mummy duck said
"Quack, quack, quack"
But only four little ducks
came back.

4, 3, 2, 1 little ducks went
swimming one day etc. etc.
No little ducks came
swimming back.
Mummy and daddy went
swimming one day
Over the pond and far away
Mummy and daddy said
"Quack, quack, quack"
And all the little ducks came
swimming back.

The wheels on the bus

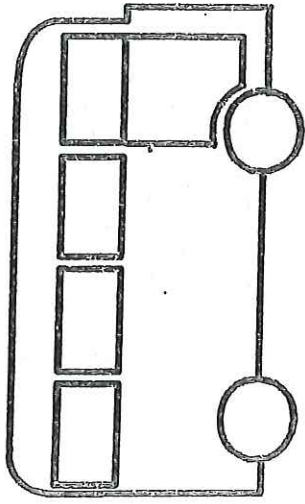

Down by the station

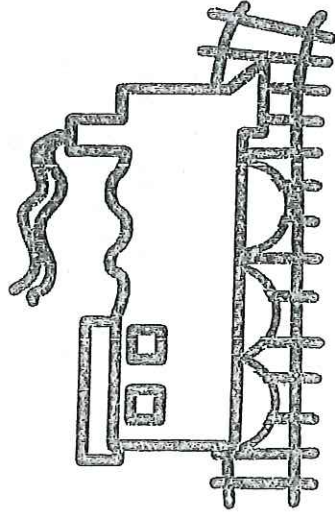

Incy Wincy Spider

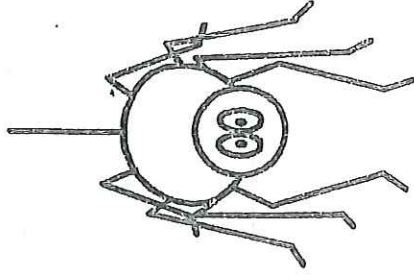

Sleepy Bunnies

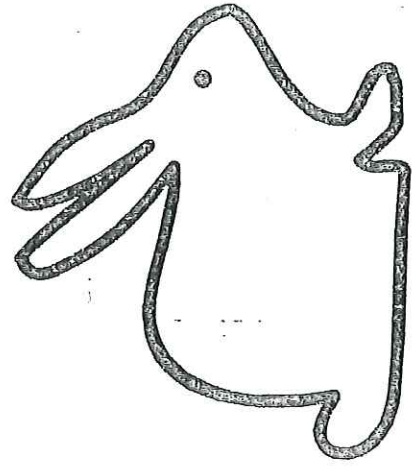

Dingle Dangle Scarecrow

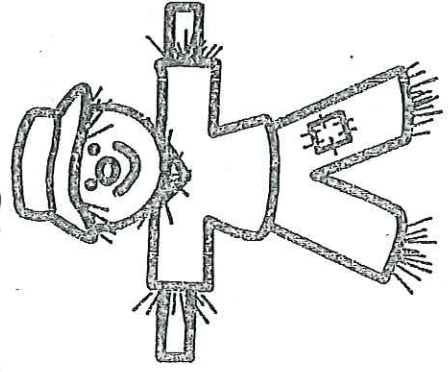

Miss Polly

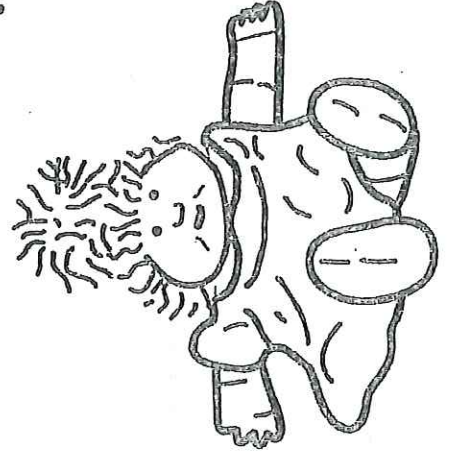

Incy Wincy Spider

Climbed the water spout,
Down came the rain and
washed poor Incy out.
Out came the sunshine and
dried up all the rain,
And Incy Wincy Spider
Climbed up the spout again.

Miss Polly had a dolly

Who was sick, sick, sick,
She phoned for the doctor
To come quick, quick, quick.
The doctor came with his
bag and his hat,
And he knocked on the door
With a rat-a-tat-tat.
He looked at the dolly and he shook
his head,
He said Miss Polly put her straight
to bed.
He wrote on a paper for a pill, pill
pill,
I'll be back in the morning.
If she still feels ill.

Down by the station
Early in the morning
See the little puffer trains
all in a row.
See the engine driver
Pull the little lever,
Peep, peep, peep,
and off we go.

When all the cows were sleeping
and the sun had gone to bed
Up jumped the scarecrow and
this is what he said
"I'm a Dingle Dangle scarecrow
with a floppy floppy hat,
I can shake my hands like this
and shake my feet like that.
When all the hens were roosting
and the sun had gone to bed
Up jumped the scarecrow and
this is what he said
"It's a Dingle Dangle

The wheels on the bus go
round and round, round and
round, round and round,
The wheels on the bus go
round and round all day
long.
The windscreen wipers go....
The bell goes,
The people go,
Etc. etc.

See the little bunnies
there,
Sleeping till it's noon,
Shall we wake them up with
a merry tune,
Oh how still,
Are they ill,
Wake up now. (clap)
Hop little bunnies hop, hop,
hop.
Hop little bunnies hop, hop
and stop.

Alphabet Song

ABC

Twinkle Twinkle Chocolate Bar

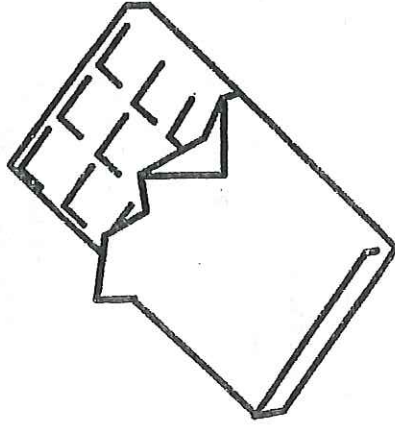

Peek

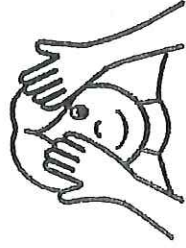

Boo

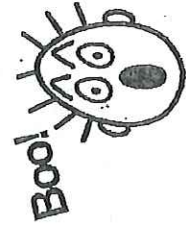

I'm a Little Teapot

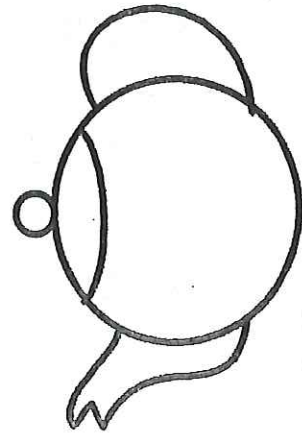

The Grand Old Duke of York

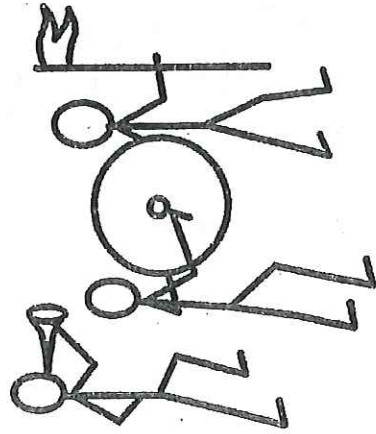

When all the cows were sleeping

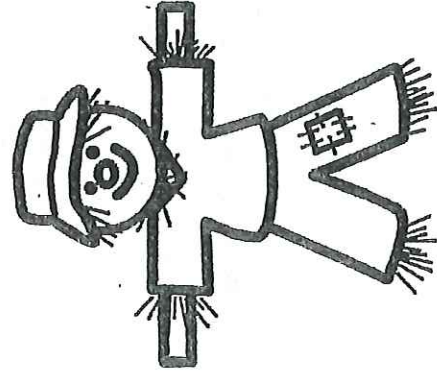

Can you play peek-a-boo
I can play peek-a-boo
Are you there?
Yes, I am
Are you there?
Yes I am
Peek-a-peek-a-peek a BOO

Twinkle, Twinkle Chocolate Bar
My dad's/mum's drives a rusty old
car
Rev up the engine
Pull out the choke
Watch it go
In a puff of smoke
Twinkle Twinkle Chocolate Bar
My dad's/mum's drives a rusty old
car.

ABCDEFGG
HIJKLMNPP
QRSTUUV
WXYZ
Now I know my ABC
Next time you can sing with
me.

When all the cows were
sleeping

And the sun had gone to bed
Up jumped the scarecrow

and this is what he said
"I'm a dingle dangle

scarecrow with a floppy
floppy hat

I can shake my hands like
this

And shake my feet like that
When all the cows were

sleeping
And the moon behind the
cloud

Up jumped the scarecrow
And shouted very loud

"I'm a dingle dangle
scarecrow etc. etc.

Oh the Grand Old Duke of York
He had 10,000 men
He marched them up
To the top of hill
And he marched
Then down again
When they were up
They were up
And when they were down
They were down
And when they were only
Half way up
They were neither up nor down

I'm a little teapot
Short and stout
Here's my handle
Here's my spout
When the kettles boiling
Hear me shout
Tip me up and pour me out

Two little dickie birds

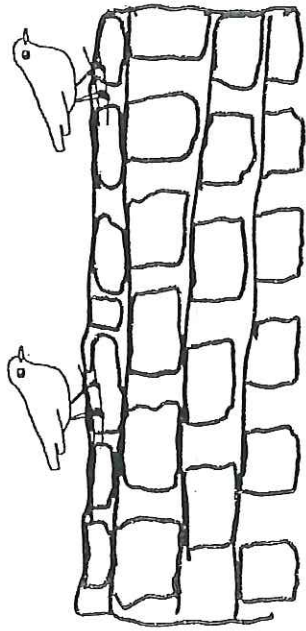

Tommy Thumb

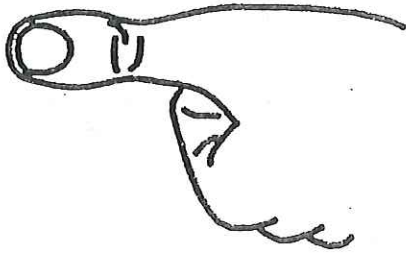

head, shoulders, knees and toes

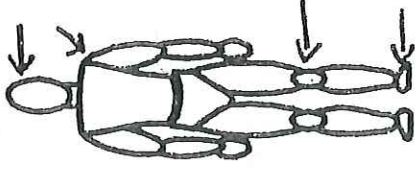

Wind the bobbin up

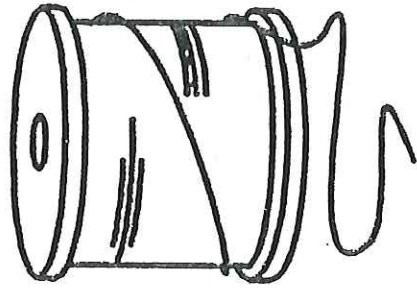

Rock a bye baby

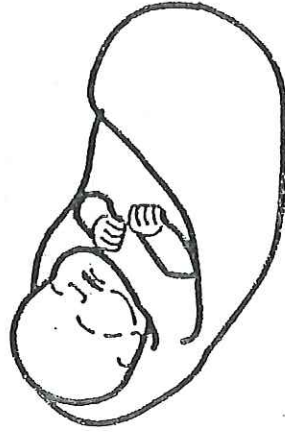

Little boy blue

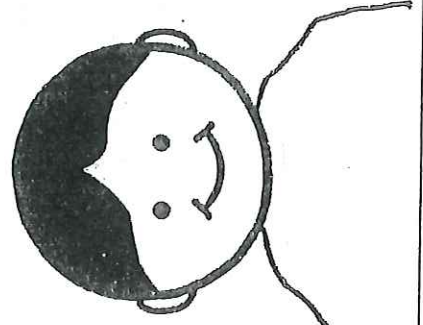

Head, shoulders, knees
and toes,
Knees and toes,
Head, shoulders, knees
and toes, knees and
toes,
And ears and eyes and
mouth and nose,
Head, shoulders, knees
and toes, knees and
toes.

Little boy blue,
Come blow up your horn,
The sheep's in the
meadow,
The cow's in the corn,
But where's the boy,
Who looks after the
sheep,
He's under the haystack
Fast asleep.

Tommy Thumb,
Tommy Thumb
Where are you ?
Here I am, Here I am,
How do you do.
Peter Pointer
Toby Tall
Ruby Ring
Baby Small
Fingers all

Rock a bye baby on the
tree top,
When the wind blows,
The cradle will rock,
When the bough breaks,
The cradle will fall,
Down will come baby,
Cradle and all.

Two little dickie birds
Sitting on a wall:
One named Peter
One named Paul.
Fly away Peter
Fly away Paul.
Come back Peter
Come back Paul.

Wind the bobbin up,
Wind the bobbin up,
Pull, pull,
Clap, clap, clap.
Point to the ceiling,
Point to the floor,
Point to the window,
Point to the door.
Clap your hands
together 1, 2, 3,
Out your hands upon
your knees.

See-Saw Margery Daw

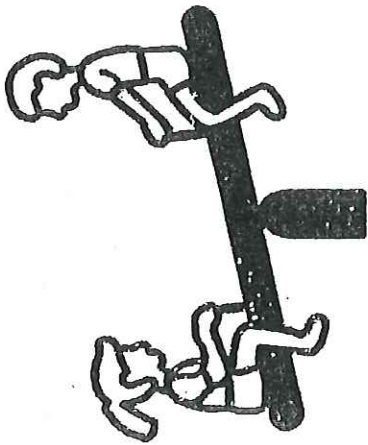

Yellow bird



1 2 3 4 5 fish



Pussy Cat, Pussy Cat

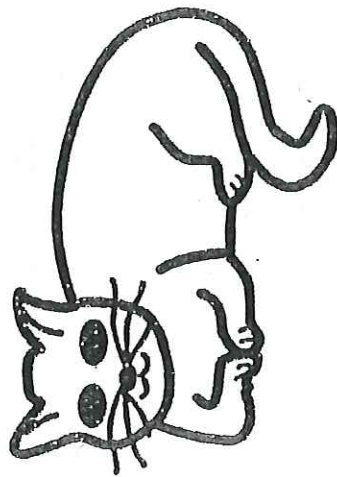

Jingle Bells

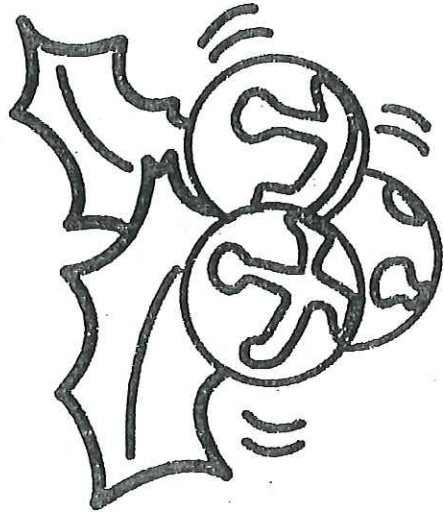

Away in a Manger

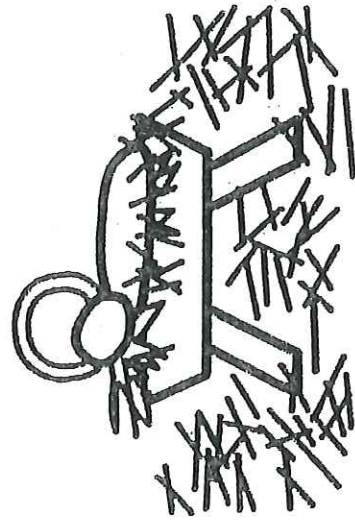

Away in a manger,
No crib for a bed,
The little Lord Jesus,
Lay down his sweet head.
The stars in the bright sky,
Look down where he lay,
The little Lord Jesus,
Asleep in the hay.

Yellow Bird way up high in
banana tree,
Yellow bird you sit all alone
like me,
Did your lady friend
Leave de nest again?
Dat is very sad
Make me feel so bad,
You can fly away
In the sky away
Your'e more lucky than me.

Jingle bells, Jingle bells,
Jingle all the way,
Oh what fun it is to ride on
a one horse open sleigh.
Jingle bells, jingle bells,
Jingle all the way,
Oh what fun it is to ride on
A one horse open sleigh.

Seesaw, Magery Daw,
Johnny shall have a new
master,
He shall have a penny a day,
Because he can't work any
faster.

Pussy cat, pussy cat,
Where have you been?
I've been to London to look
at the Queen.
Pussy cat, pussy cat
What did you there?
I frightened a mouse
Right under the chair.

Two little dickie birds

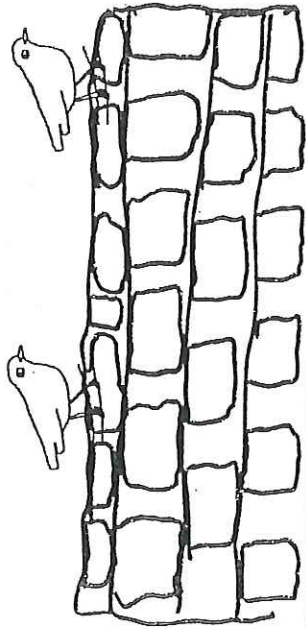

Tommy Thumb

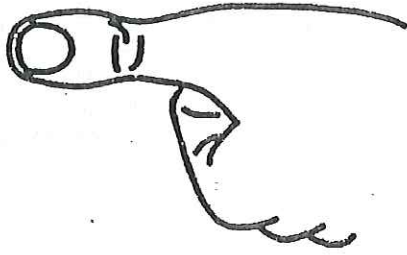

head, shoulders, knees and toes

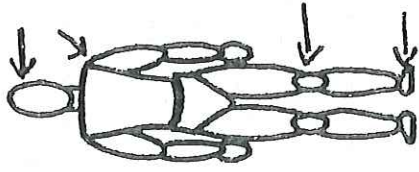

Wind the bobbin up

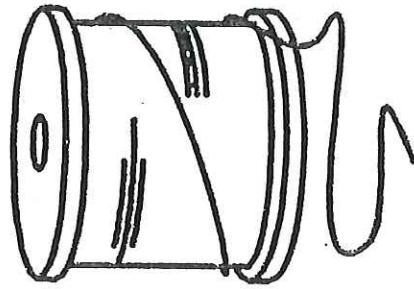

Rock a bye baby



Little boy blue

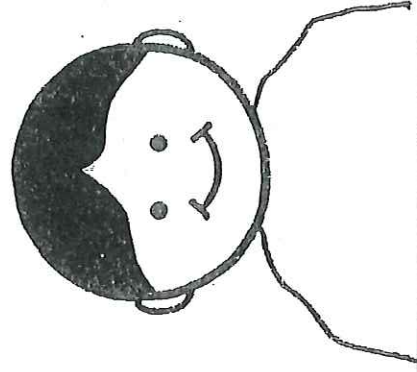

Head, shoulders, knees
and toes,
Knees and toes,
Head, shoulders, knees
and toes, knees and
toes,
And ears and eyes and
mouth and nose,
Head, shoulders, knees
and toes, knees and
toes.

Little boy blue,
Come blow up your horn,
The sheep's in the
meadow,
The cow's in the corn,
But where's the boy,
Who looks after the
sheep,
He's under the haystack
Fast asleep.

Tommy Thumb,
Tommy Thumb
Where are you ?
Here I am, Here I am,
How do you do.
Peter Pointer
Toby Tall
Ruby Ring
Baby Small
Fingers all

Rock a bye baby on the
tree top,
When the wind blows,
The cradle will rock,
When the bough breaks,
The cradle will fall,
Down will come baby,
Cradle and all.

Two little dickie birds
Sitting on a wall.
One named Peter
One named Paul.
Fly away Peter
Fly away Paul.
Come back Peter
Come back Paul.

Wind the bobbin up,
Wind the bobbin up,
Pull, pull,
Clap, clap, clap.
Point to the ceiling,
Point to the floor,
Point to the window,
Point to the door.
Clap your hands
together 1, 2, 3,
Out your hands upon
your knees.

Language Group Training

Introductions and information sharing

- Who is the group for?
- What are the children's needs/what do you hope to achieve?
- What pressures are there to consider?
- What is happening now? Have the children had any experience of small groups?

Planning a group (things to consider)

- size of group
- composition of the group (staff and children)
- Who might be a role model?
- What activities will you do/how will the activities link into themes being studied in the classroom?
- What will the environment be like?
- What time of day is best?
- What staff do you have available/who will lead and who will support?

What do you want to teach?

Think about the social skills needed for conversation

- Saying hello and good-bye (also offers a clear start and finish to the session)
- How do we feel? Using a mirror to examine facial expressions and emotion cards to name the emotion.
- Taking turns... lead adult aims to hold control and children engage on your terms. Putting props in a bag/box which you hold onto may help. Encourage children to give the object to the next person in line to build group awareness.
- Understanding the rules. Use the positive reinforcement cards to explain what is expected of them in the group session.

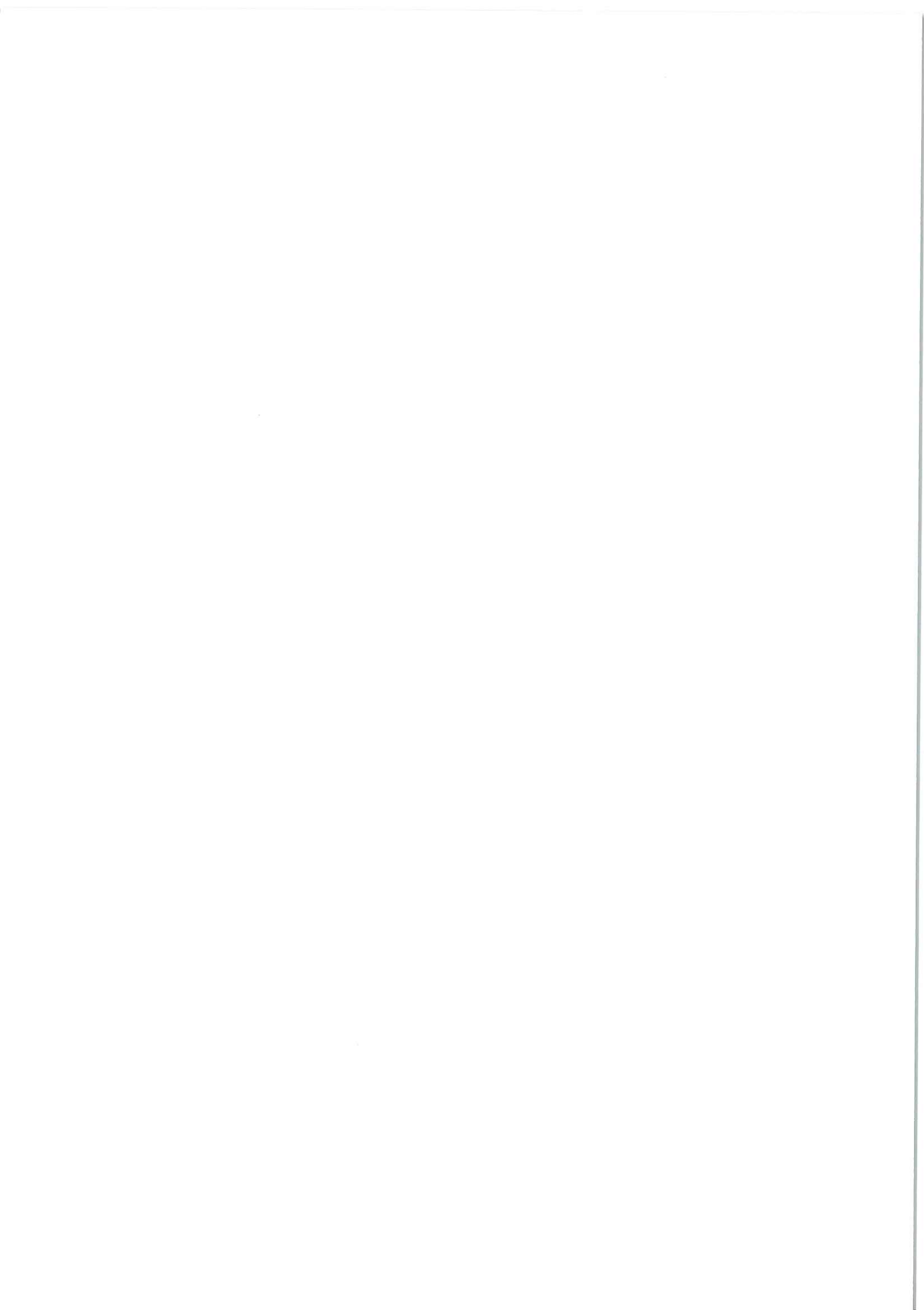

- Building attention and listening skills. Motivators are key! Props and visual support essential.

What might a session look like?

1. Introduce visual timeline of session....this is what we are going to do.
2. Hello song (photos, mirror, emotion cards)
3. Turn taking activities (e.g. cars and cardboard tube/train track pieces/ noisy insert puzzle)
4. Story time (book, props, sound makers, relevant symbols)
5. Treasure box....highly motivating objects not normally available in the school)
6. Goodbye song

Return to the visual timetable after each section to post the relevant symbol in the finish box e.g. 'hello time is finished, now it's time for turn taking'.

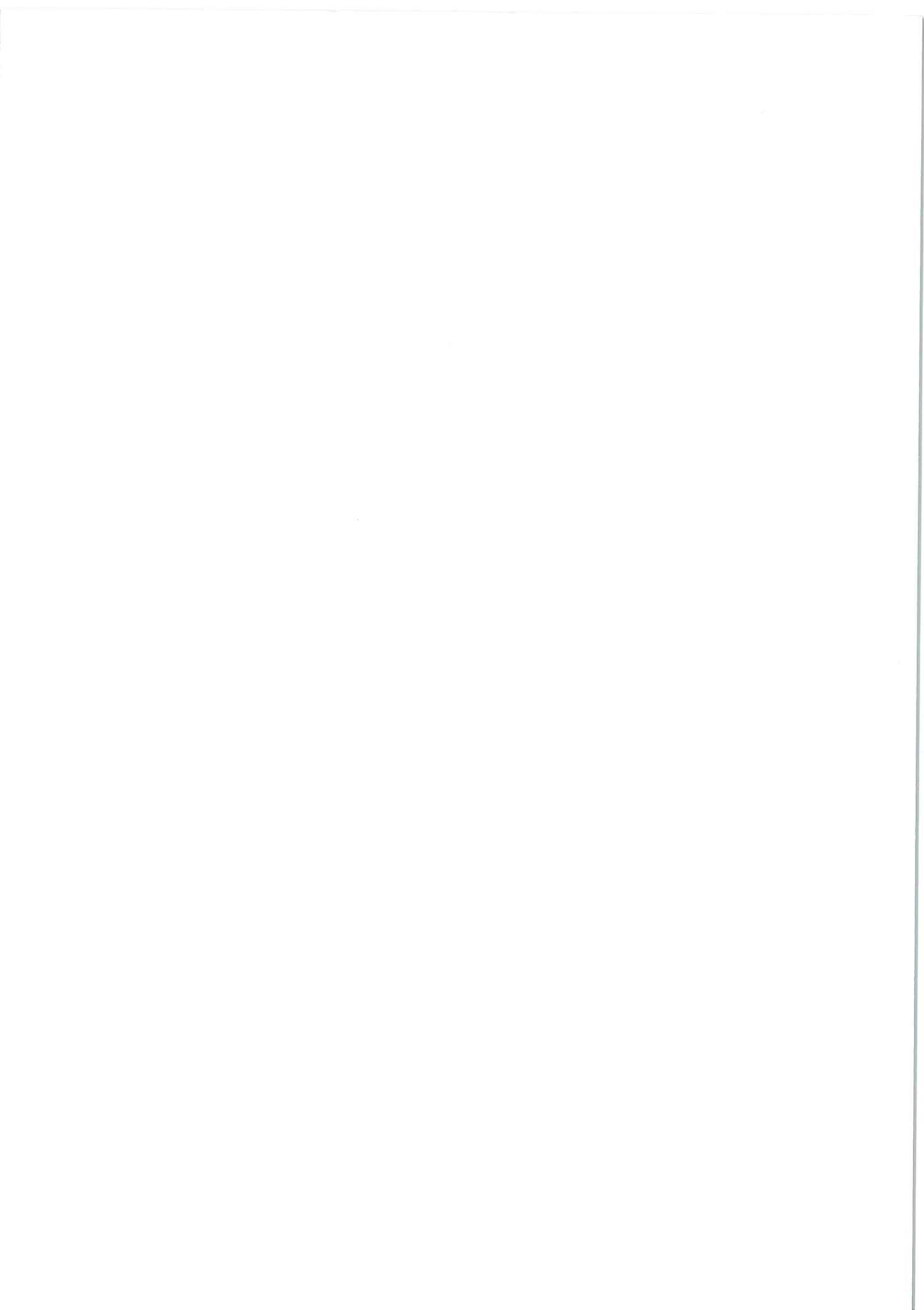





Treasure box

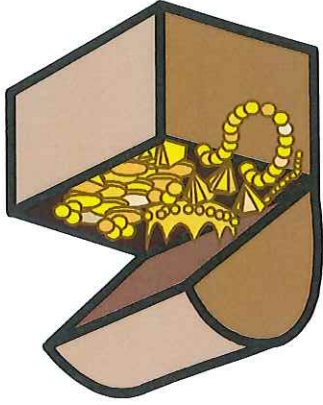

Turn taking game

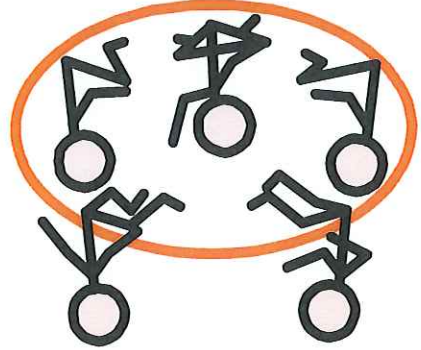

Songs

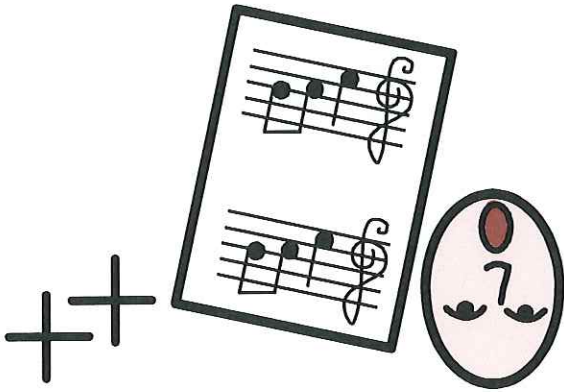

Story

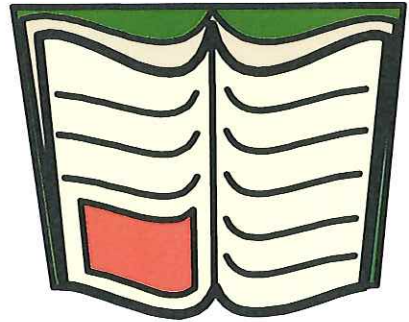

How are you

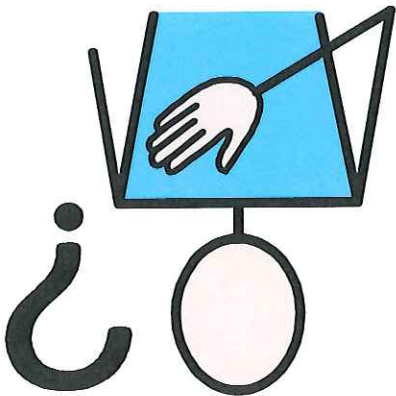

Hello

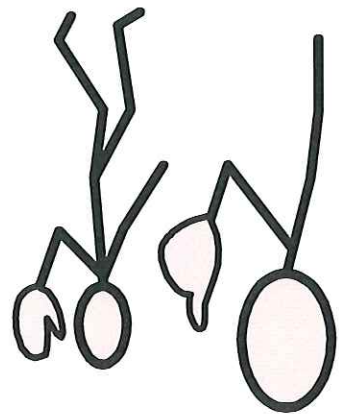

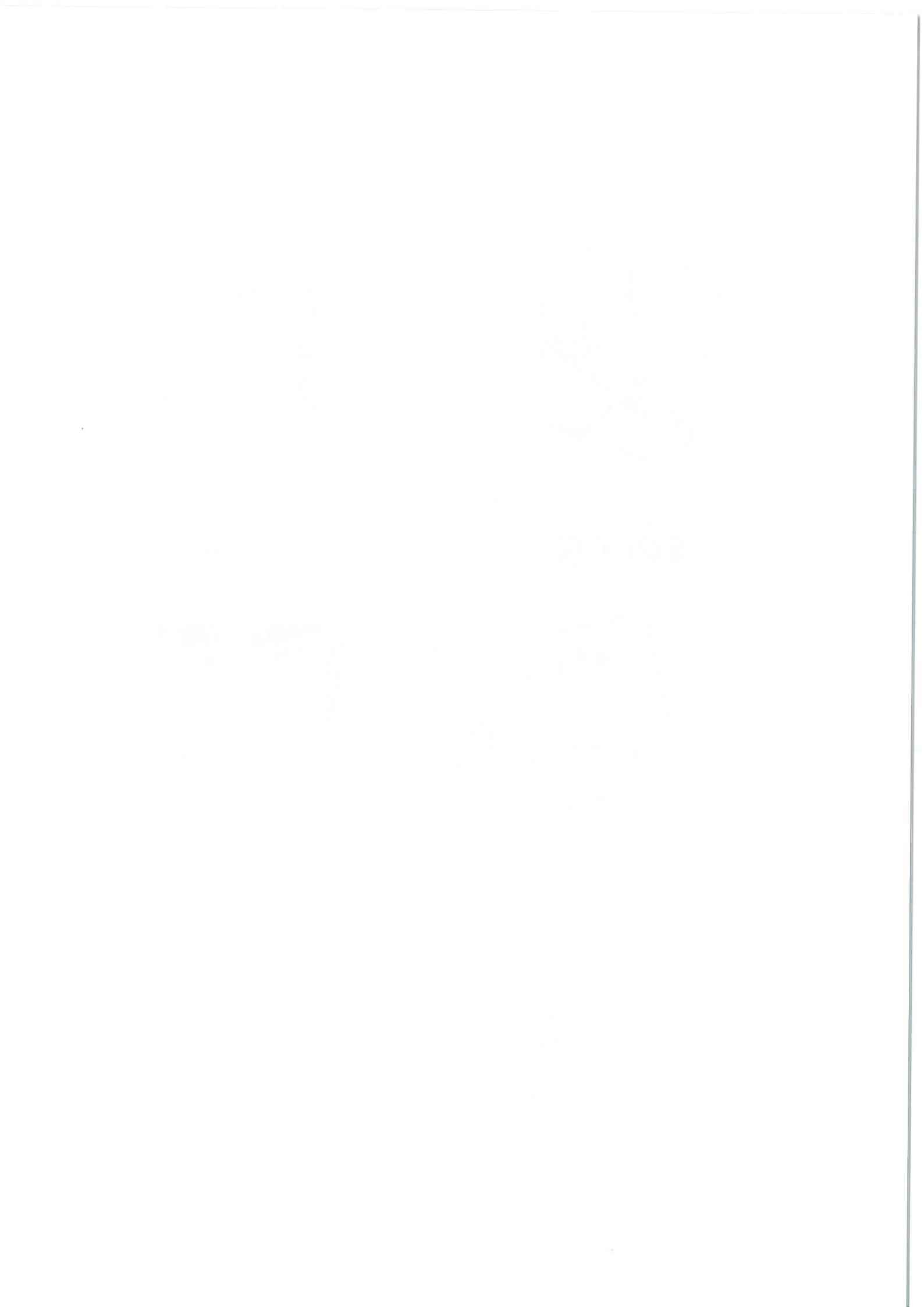

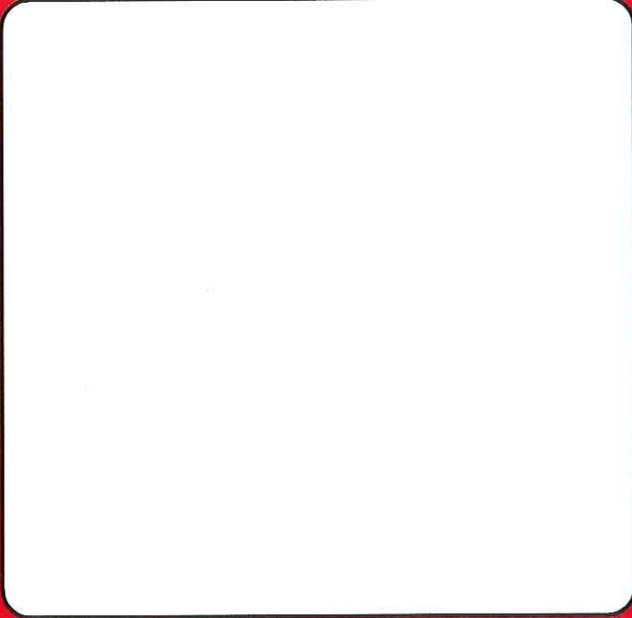
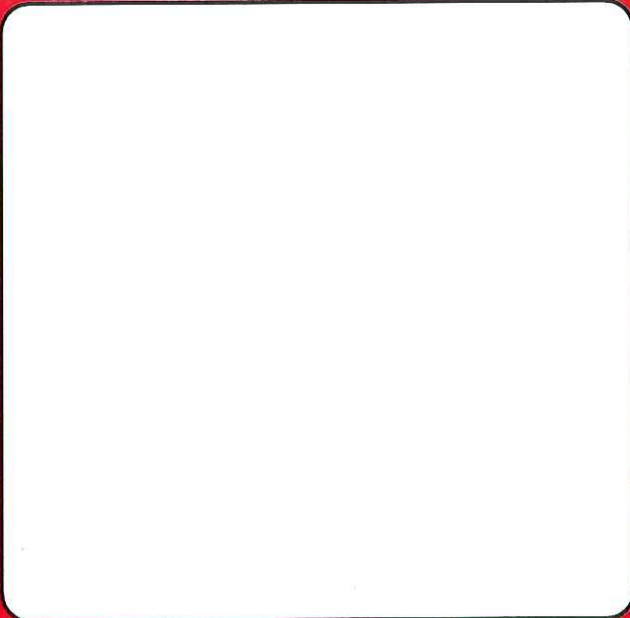
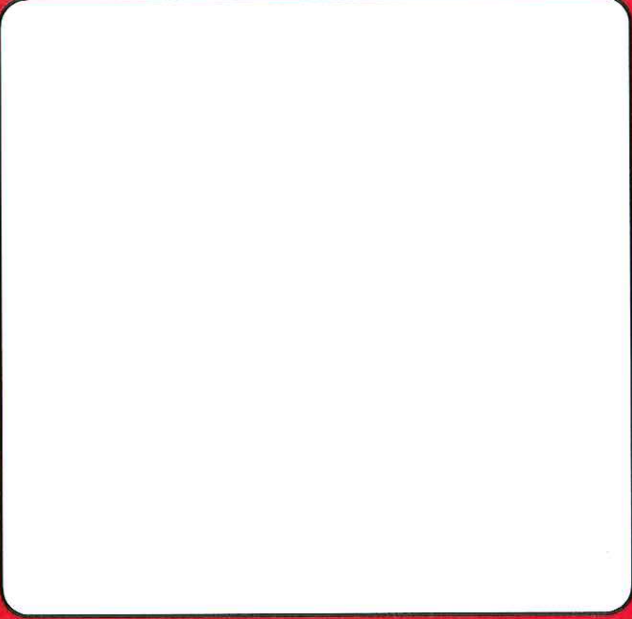
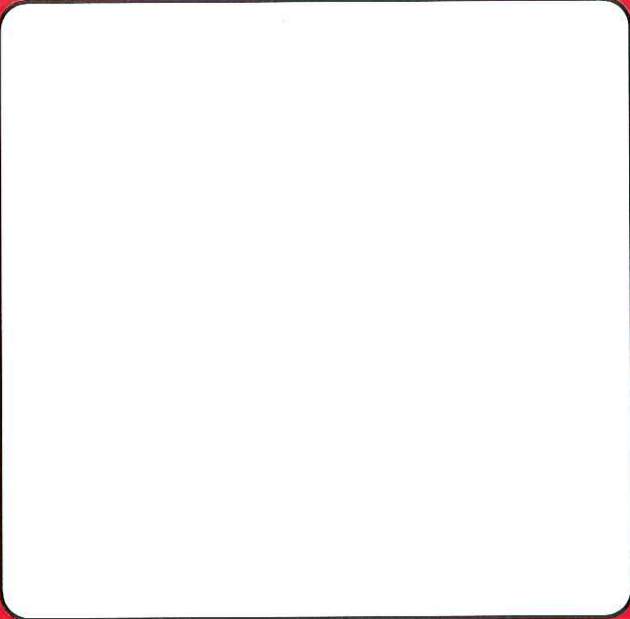

Puzzle

An illustration of four interlocking puzzle pieces. One piece is red, one is yellow, and two are blue. The pieces are arranged in a small cluster.

Goodbye

A simple line drawing of a hand with fingers spread, waving. A vertical line extends upwards from the center of the hand, and two diagonal lines extend outwards from the wrist, suggesting movement or a wave.

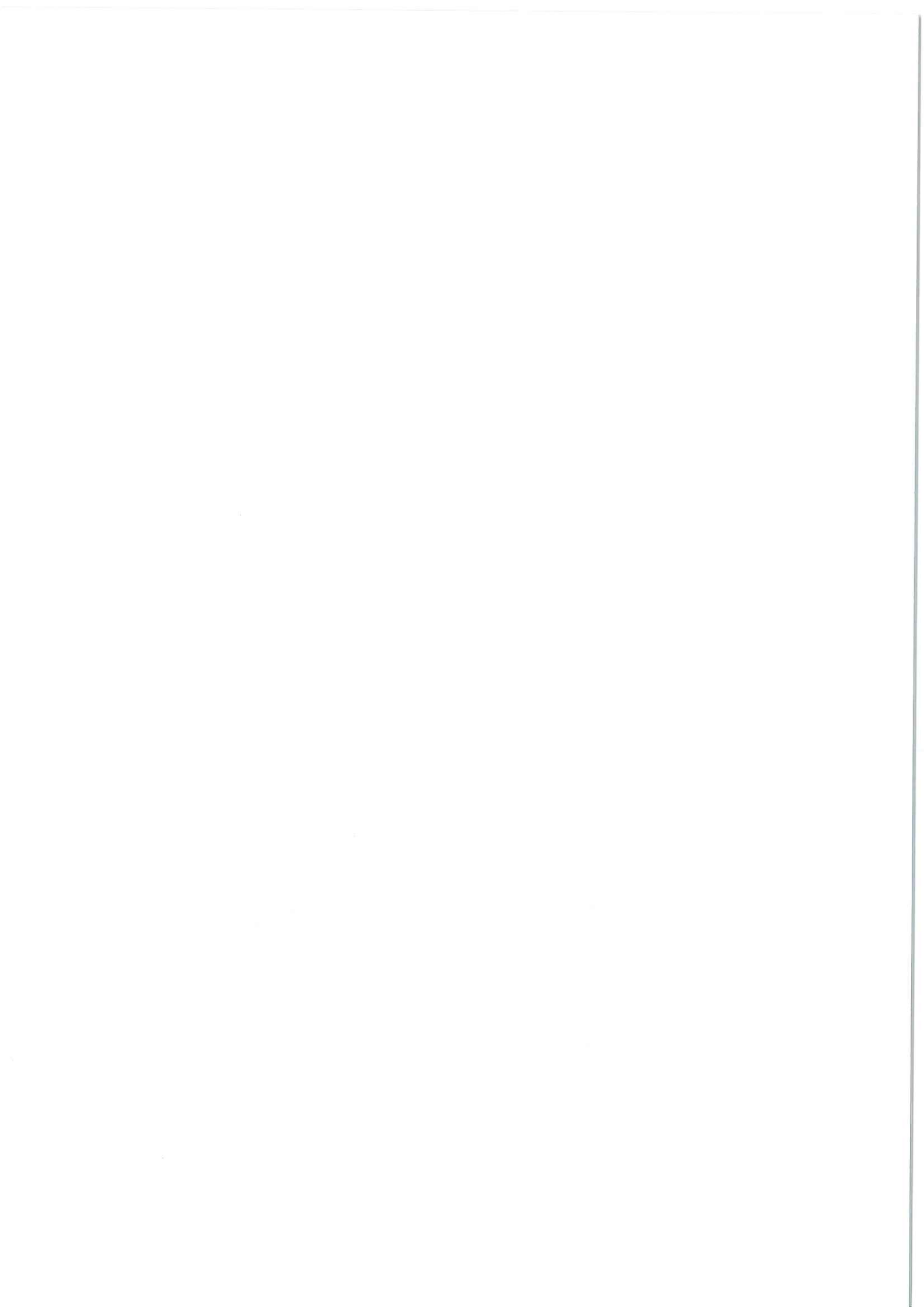

emotions

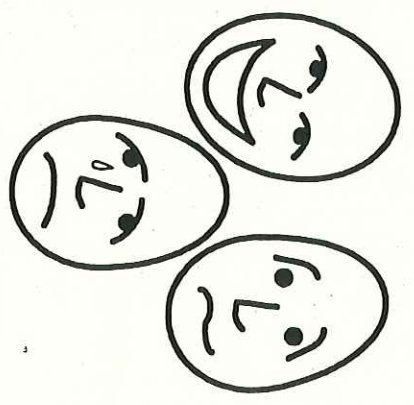

happy

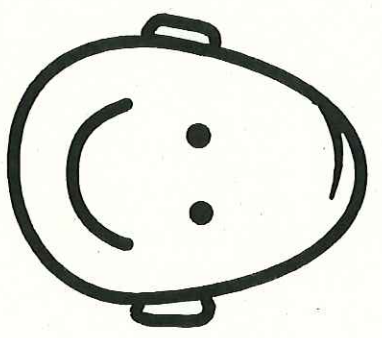

sad

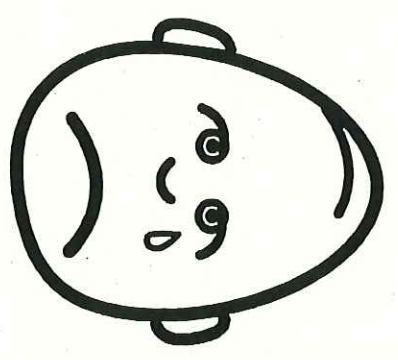

tired

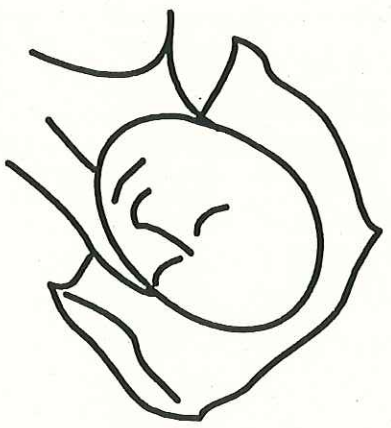

don't know

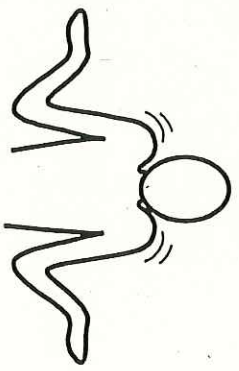

not well

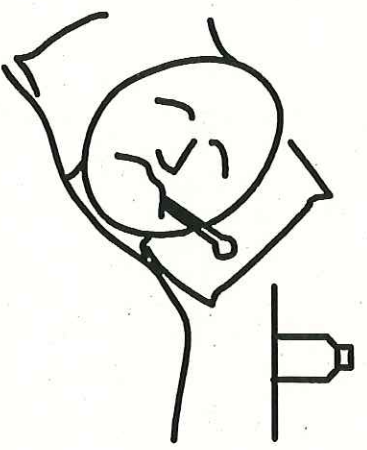

1870



1871



1872



feet down

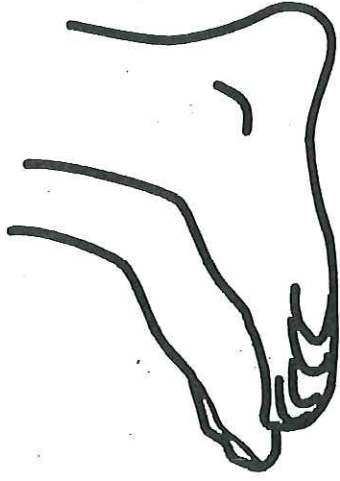

hands down

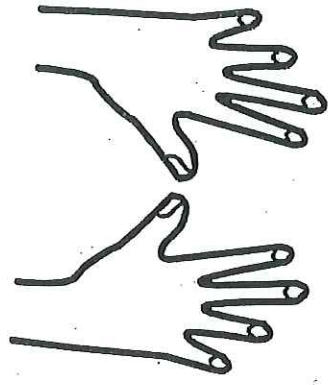

good listening

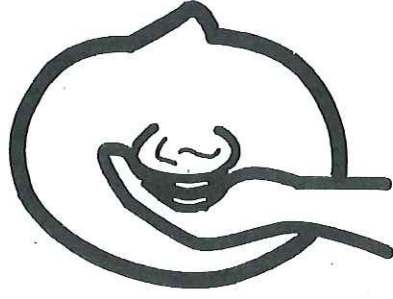

good looking



quiet voice

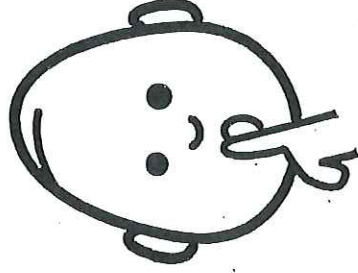

good sitting

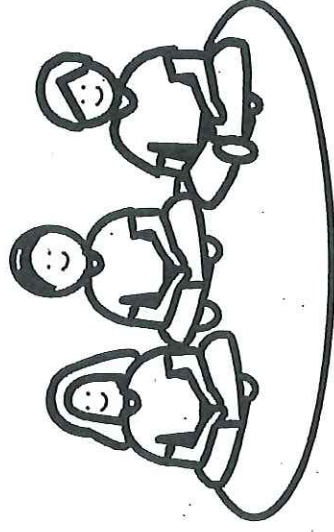

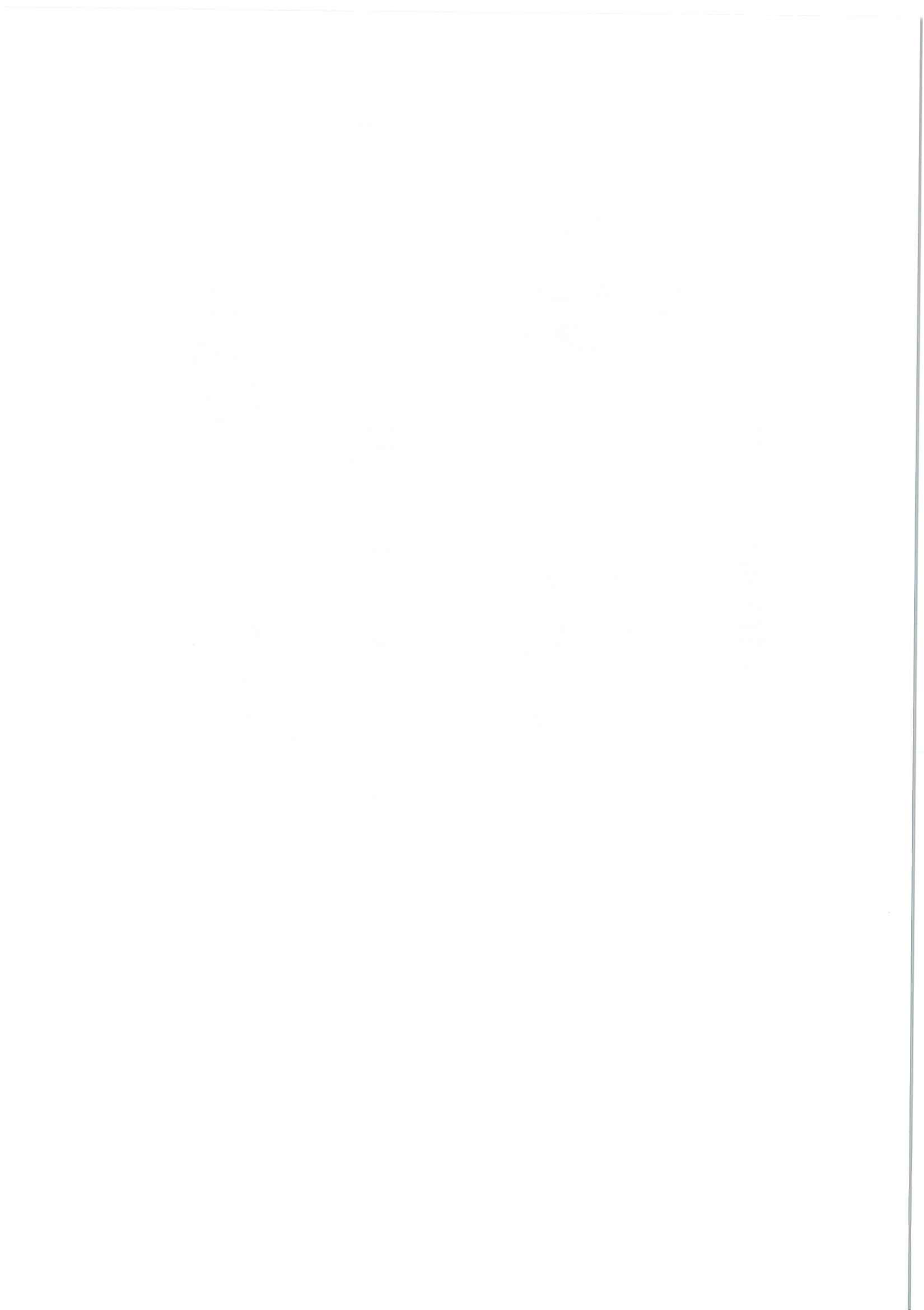

Ten in the bed

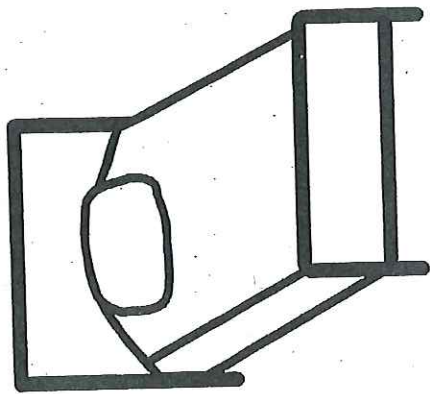

1 2 3 4 5

6 7 8 9 10

Five Little Monkeys

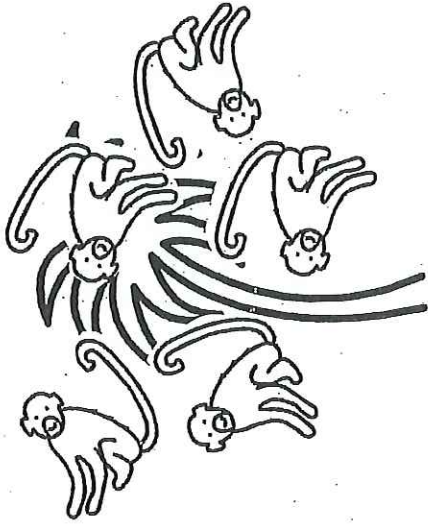

Five bears sitting on the wall

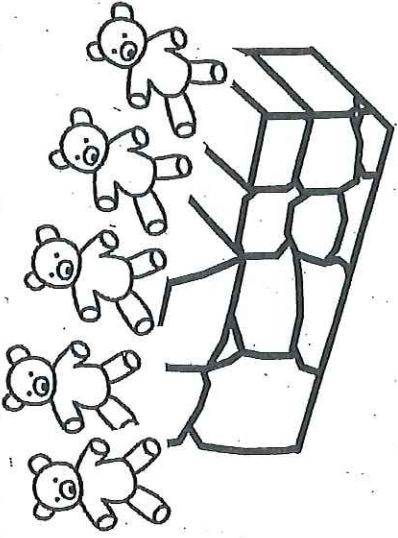

Five little ducks

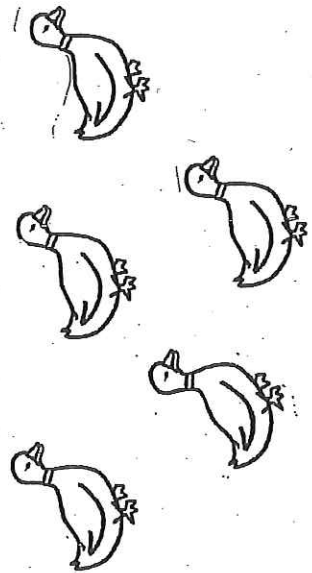

Five little frogs

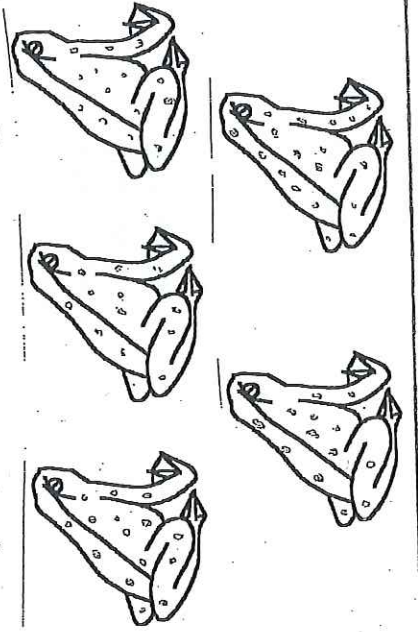

Pizza Hut

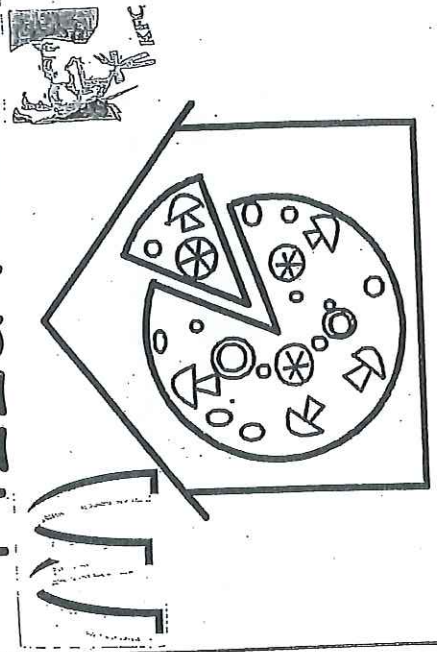

Five little bears
Sitting on the wall
Five little teddy bears
Sitting on the wall
And if one little bear
Should accidentally fall
There'd be four, three, two,
one, no little bears sitting on
the wall.

Five little monkeys
Swinging in the tree
Teasing Mr. Crocodile
"You can't catch me, you
can't catch me."
Along came Mr. Crocodile
As quiet as can be
And SNAP
He took a little monkey home
To have some tea.

There were ten in the bed
And the little one said
"Roll over, roll over!"
So they all rolled over
And one fell out.
There were 9, 8, 7, 6, 5, 4, 3, 2, 1
In the bed
Then there were none in the
bed
And the little one said

A Pizza Hut
A Pizza Hut
Kentucky Fried Chicken and a
Pizza Hut
Macconalds, Macconalds
Kentucky Fried Chicken
And a Pizza Hut

Five little speckled frogs
Sat on a speckled log
Eating the most delicious
grubs
Yum, Yum
One jumped into the pool
Where it was nice and cool
Then there were four green
speckled frogs
GLUB GLUB.

Five little ducks
Went swimming one day
Over pond/hills and faraway
Mummy duck said
"Quack, quack, quack!"
But only four little ducks
came back.

4, 3, 2, 1 little ducks went
swimming one day etc. etc.
No little ducks came
swimming back.

4, 3, 2, 1 little speckled
frogs
etc. etc.

Mummy and daddy went
swimming one day
Over the pond and far away
Mummy and daddy said
"Quack, quack, quack!"
And all the little ducks

Alphabet Song

ABC

Twinkle Twinkle Chocolate Bar

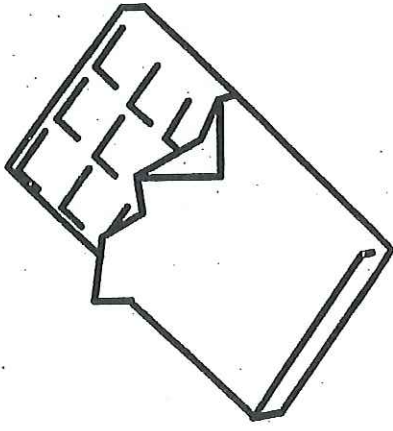

Peek

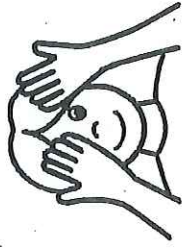

Boo

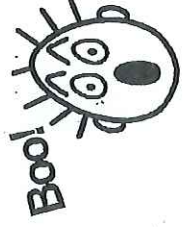

Hum a Little Teapot

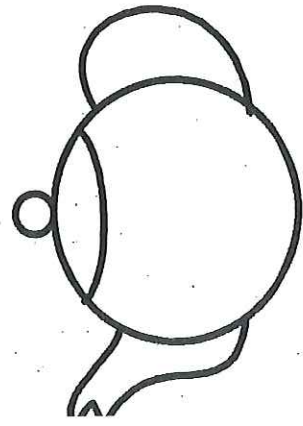

The Grand Old Duke of York

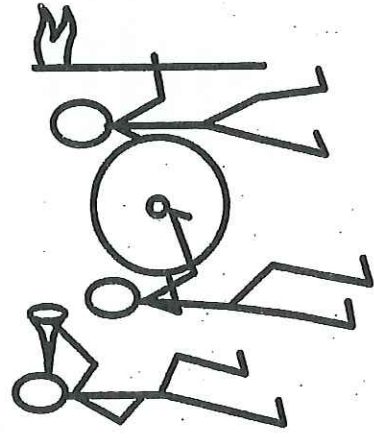

When all the cows were sleeping

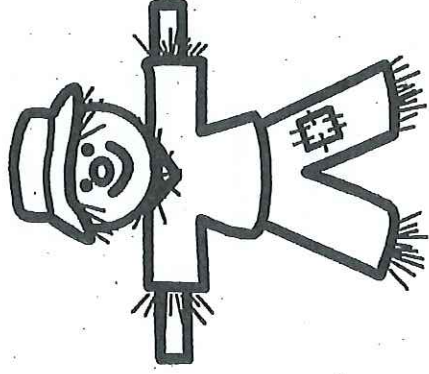

Can you play peek-a-boo
I can play peek-a-boo
Are you there?
Yes, I am
Are you there?
Yes I am
Peek-a-peek-a-peek a BOO

Twinkle, Twinkle Chocolate Bar
My dad's/mum's drives a rusty old
car
Rev up the engine
Pull out the choke
Watch it go
In a puff of smoke
Twinkle Twinkle Chocolate Bar
My dad's/mum's drives a rusty old
car.

ABCDEFGG
HIJKLMNPP
QRSTUUV
WXYZ
Now I know my ABC
Next time you can sing with
me.

When all the cows were
sleeping
And the sun had gone to bed
Up jumped the scarecrow
and this is what he said
"I'm a dingle dangle
scarecrow with a floppy
floppy hat
I can shake my hands like
this
And shake my feet like that
When all the cows were
sleeping
And the moon behind the
cloud
Up jumped the scarecrow
And shouted very loud
"I'm a dingle dangle
scarecrow etc. etc.

Oh the Grand Old Duke of York
He had 10,000 men
He marched them up
To the top of hill
And he marched
Them down again
When they were up
They were up
And when they were down
They were down
And when they were only
Half way up
They were neither up nor down

I'm a little teapot
Short and stout
Here's my handle
Here's my spout
When the kettles boiling
Hear me shout
Tip me up and pour me out

Alphabet Song

ABC

Twinkle Twinkle Chocolate Bar

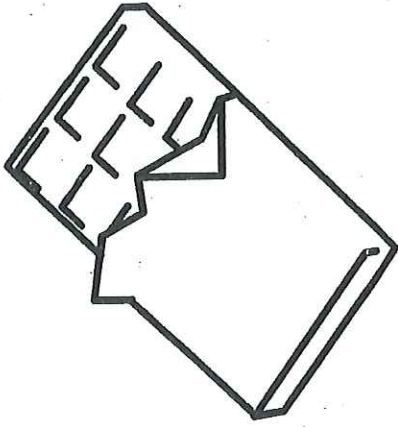

Peek

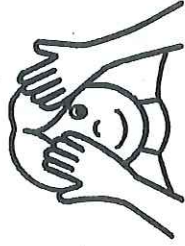

Boo

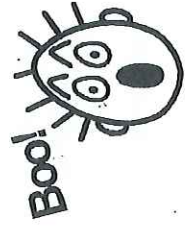

I'm a Little Teapot

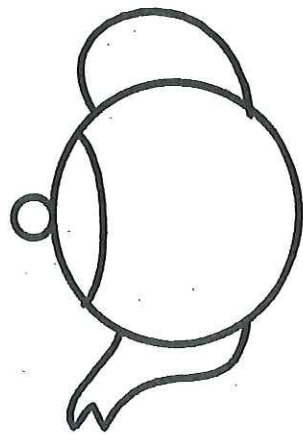

The Grand Old Duke of York

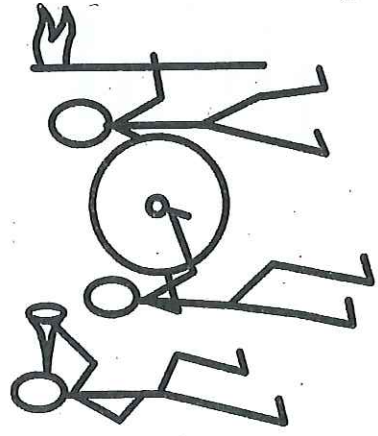

When all the cows were sleeping

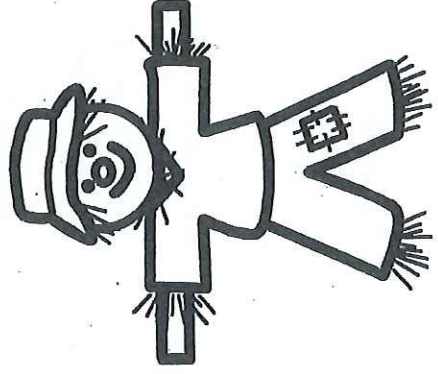

Can you play peek-a-boo
I can play peek-a-boo
Are you there?
Yes, I am
Are you there?
Yes I am
Peek-a-peek-a-peek a BOO

Twinkle, Twinkle Chocolate Bar
My dad's/mum's drives a rusty old
car
Rev up the engine
Pull out the choke
Watch it go
In a puff of smoke
Twinkle Twinkle Chocolate Bar
My dad's/mum's drives a rusty old
car.

ABCDEFGH
IJKLMNOP
QRSTUW
WXYZ
Now I know my ABC
Next time you can sing with
me.

When all the cows were
sleeping
And the sun had gone to bed
Up jumped the scarecrow
and this is what he said
"I'm a dingle dangle
scarecrow with a floppy
floppy hat
I can shake my hands like
this
And shake my feet like that
When all the cows were
sleeping
And the moon behind the
cloud
Up jumped the scarecrow
And shouted very loud
"I'm a dingle dangle
scarecrow etc. etc.

Oh the Grand Old Duke of York
He had 10,000 men
He marched them up
To the top of hill
And he marched
Them down again
When they were up
They were up
And when they were down
They were down
And when they were only
Half way up
They were neither up nor down

I'm a little teapot
Short and stout
Here's my handle
Here's my spout
When the kettles boiling
Hear me shout
Tip me up and pour me out

Alphabet Song

ABC

Twinkle Twinkle Chocolate Bar

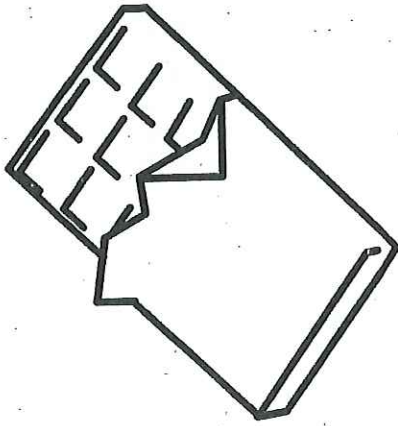

Peek

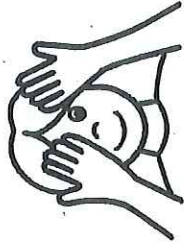

Boo

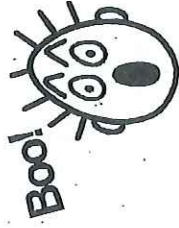

'm a Little Teapot

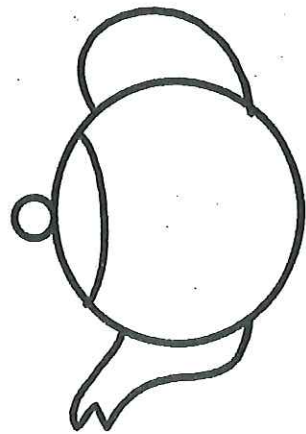

The Grand Old Duke of York

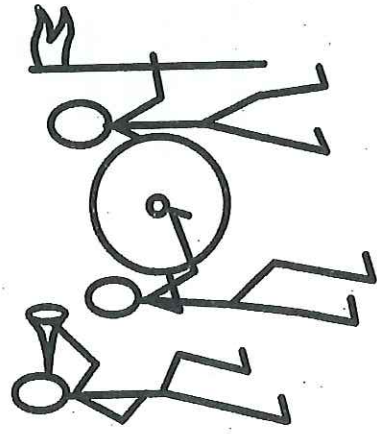

When all the cows were sleeping

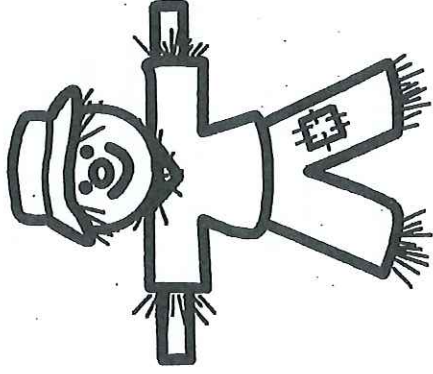

Can you play peek-a-boo
I can play peek-a-boo
Are you there?
Yes, I am
Are you there?
Yes I am

Peek-a-peek-a-peek a BOO

Twinkle, Twinkle Chocolate Bar
My dad's/mum's drives a rusty old
car
Rev up the engine
Pull out the choke
Watch it go
In a puff of smoke
Twinkle Twinkle Chocolate Bar
My dad's/mum's drives a rusty old
car.

ABCDEFGH
IJKLMNOP
QRSTUW
WXYZ
Now I know my ABC
Next time you can sing with
me.

When all the cows were
sleeping

And the sun had gone to bed
Up jumped the scarecrow

and this is what he said

"I'm a dingle dangle
scarecrow with a floppy
floppy hat

I can shake my hands like
this

And shake my feet like that
When all the cows were
sleeping

And the moon behind the
cloud

Up jumped the scarecrow

And shouted very loud

"I'm a dingle dangle

scarecrow etc. etc.

Oh the Grand Old Duke of York

He had 10,000 men

He marched them up

To the top of hill

And he marched

Them down again

When they were up

They were up

And when they were down

They were down

And when they were only

Half way up

They were neither up nor down

I'm a little teapot
Short and stout
Here's my handle
Here's my spout
When the kettles boiling
Hear me shout
Tip me up and pour me out

Alphabet Song

ABC

Twinkle Twinkle Chocolate Bar

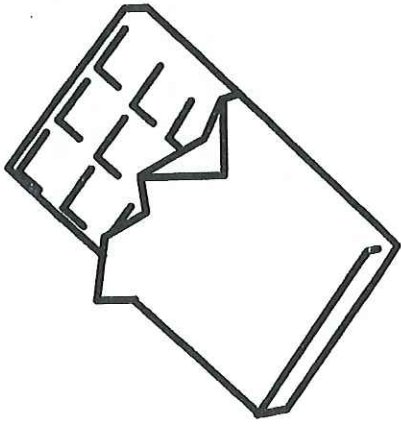

Peek

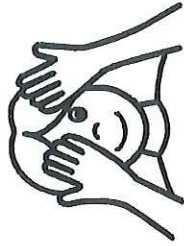

Boo

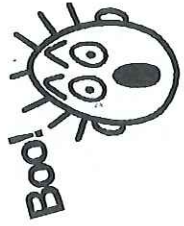

'm a Little Teapot

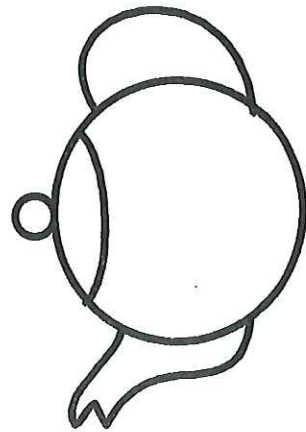

The Grand Old Duke of York

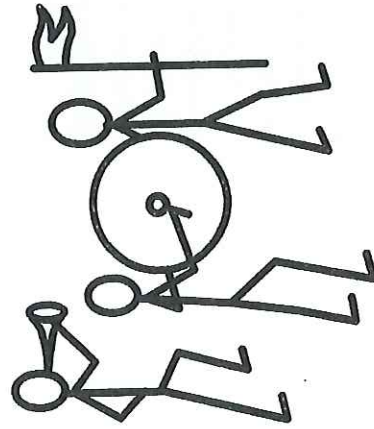

When all the cows were sleeping

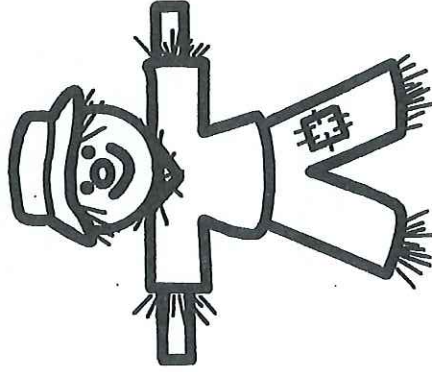

Can you play peek-a-boo
I can play peek-a-boo
Are you there?
Yes, I am
Are you there?
Yes I am
Peek-a-peek-a-peek a BOO

Twinkle, Twinkle Chocolate Bar
My dad's/mum's drives a rusty old
car
Rev up the engine
Pull out the choke
Watch it go
In a puff of smoke
Twinkle Twinkle Chocolate Bar
My dad's/mum's drives a rusty old
car.

ABCDEFGH
IJKLMNOP
QRSTUVWXYZ
WXYZ
Now I know my ABC
Next time you can sing with
me.

When all the cows were
sleeping
And the sun had gone to bed
Up jumped the scarecrow
and this is what he said
"I'm a dingle dangle
scarecrow with a floppy
floppy hat
I can shake my hands like
this
And shake my feet like that
When all the cows were
sleeping
And the moon behind the
cloud
Up jumped the scarecrow
And shouted very loud
"I'm a dingle dangle
scarecrow etc. etc.

Oh the Grand Old Duke of York
He had 10,000 men
He marched them up
To the top of hill
And he marched
Them down again
When they were up
They were up
And when they were down
They were down
And when they were only
Half way up
They were neither up nor down

I'm a little teapot
Short and stout
Here's my handle
Here's my spout
When the kettles boiling
Hear me shout
Tip me up and pour me out

Ten in the bed

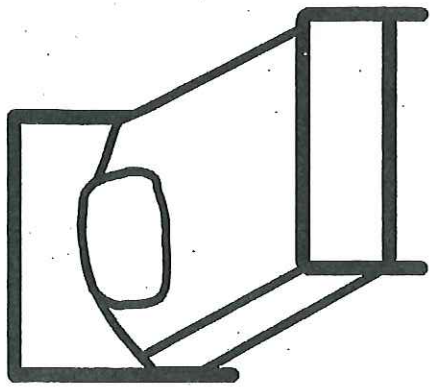

1 2 3 4 5

6 7 8 9 10

Five Little Monkeys

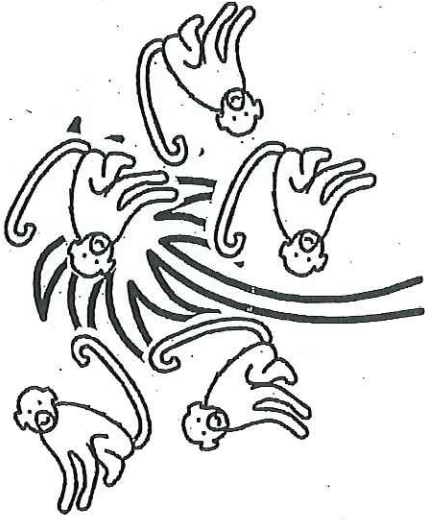

Five bears sitting on the wall

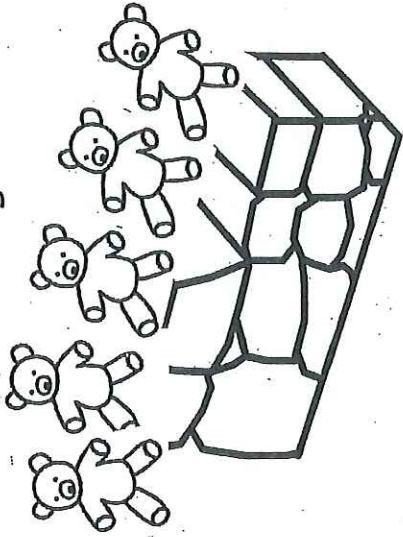

Five little ducks

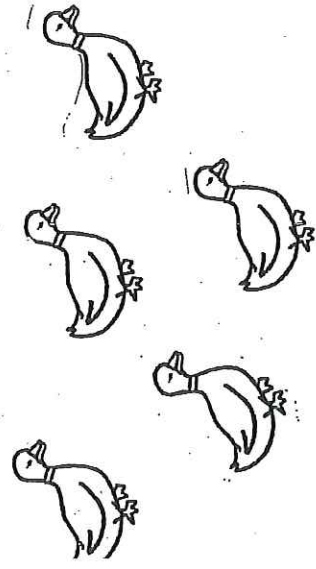

Five little frogs

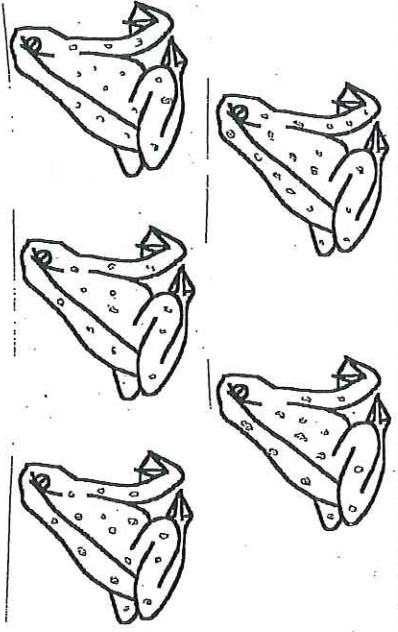

Pizza Hut

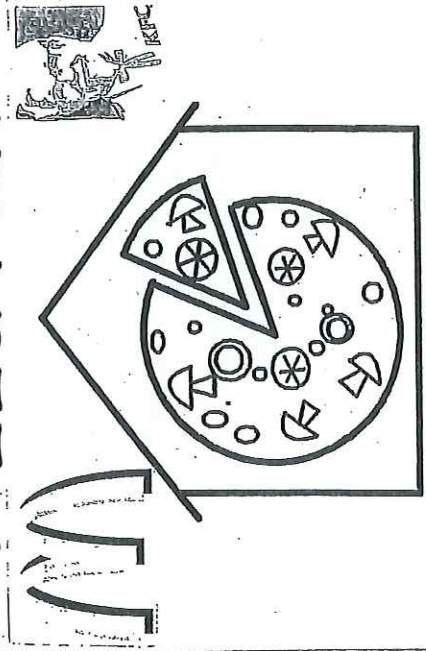

Five little bears
Sitting on the wall
Five little teddy bears
Sitting on the wall
And if one little bear
Should accidentally fall
There'd be four, three, two,
one, no little bears sitting on
the wall.

Five little monkeys
Swinging in the tree
Teasing Mr. Crocodile
"You can't catch me, you
can't catch me!"
Along came Mr. Crocodile
As quiet as can be
And SNAP
He took a little monkey home
To have some tea.

There were ten in the bed
And the little one said
"Roll over, roll over!"
So they all rolled over
And one fell out.
There were 9, 8, 7, 6, 5, 4, 3, 2, 1
In the bed
Then there were none in the
bed
And the little one said

A Pizza Hut
A Pizza Hut
Kentucky Fried Chicken and a
Pizza Hut
Macdonalds, Macdonalds
Kentucky Fried Chicken
And a Pizza Hut

Five little speckled frogs
Sat on a speckled log
Eating the most delicious
grubs
Yum, Yum
One jumped into the pool
Where it was nice and cool
Then there were four green
speckled frogs
GLUB GLUB.
4, 3, 2, 1 little speckled
frogs
etc. etc.

Five little ducks
Went swimming one day
Over pond/hills and faraway
Mummy duck said
"Quack, quack, quack!"
But only four little ducks
came back.

4, 3, 2, 1 little ducks went
swimming one day etc. etc.
No little ducks came
swimming back.

Mummy and daddy went
swimming one day
Over the pond and far away
Mummy and daddy said
"Quack, quack, quack!"
And all the little ducks came
swimming back.

Alphabet Song

ABC

Twinkle Twinkle Chocolate Bar

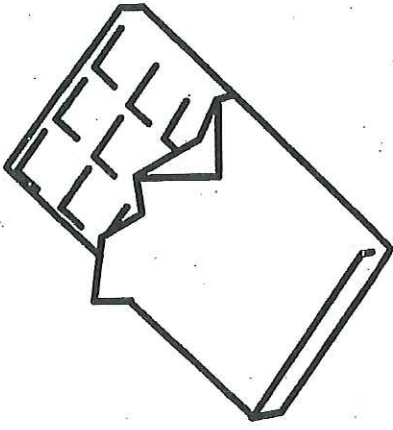

Peek

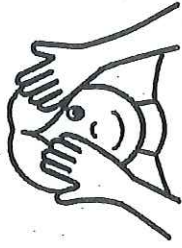

Boo

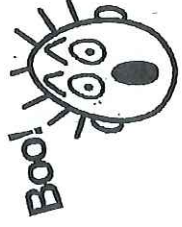

Humpty Dumpty in a Little Teapot

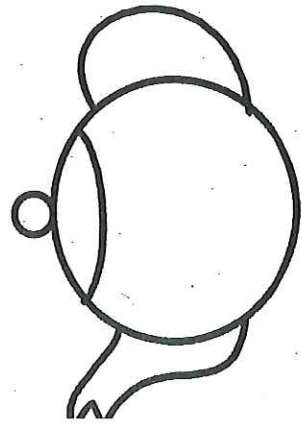

The Grand Old Duke of York

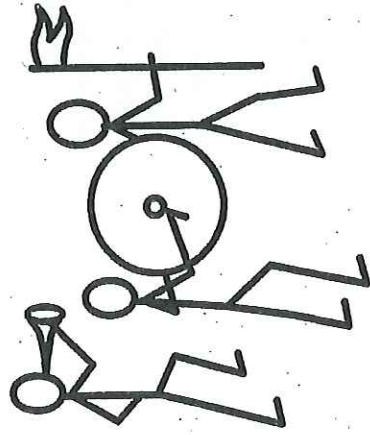

When all the cows were sleeping

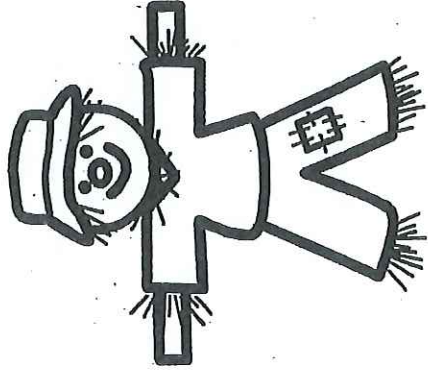

Can you play peek-a-boo
I can play peek-a-boo
Are you there?
Yes, I am
Are you there?
Yes I am
Peek-a-peek-a-peek a BOO

Twinkle, Twinkle Chocolate Bar
My dad's/mum's drives a rusty old
car
Rev up the engine
Pull out the choke
Watch it go
In a puff of smoke
Twinkle Twinkle Chocolate Bar
My dad's/mum's drives a rusty old
car.

ABCDEFGG
HIJKLMNPP
QRSTUUV
WXXYZ
Now I know my ABC
Next time you can sing with
me.

When all the cows were
sleeping

And the sun had gone to bed
Up jumped the scarecrow

and this is what he said

"I'm a dingle dangle

scarecrow with a floppy

floppy hat

I can shake my hands like

this

And shake my feet like that

When all the cows were

sleeping

And the moon behind the

cloud

Up jumped the scarecrow

And shouted very loud

"I'm a dingle dangle

scarecrow etc. etc.

Oh the Grand Old Duke of York
He had 10,000 men
He marched them up
To the top of hill
And he marched
Them down again
When they were up
They were up
And when they were down
They were down
And when they were only
Half way up
They were neither up nor down

I'm a little teapot
Short and stout
Here's my handle
Here's my spout
When the kettles boiling
Hear me shout
Tip me up and pour me out

Tommy Thumb

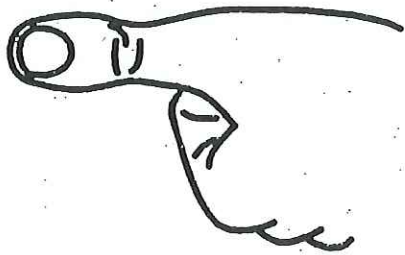

head, shoulders, knees and toes

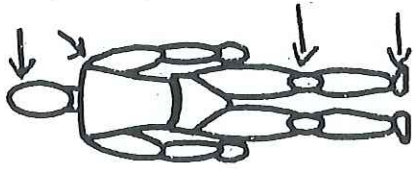

Wind the bobbin up

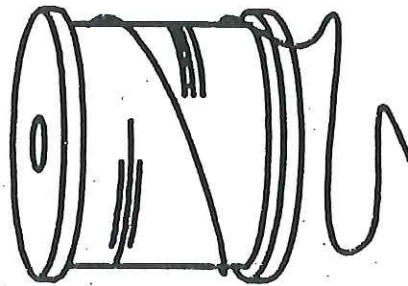

Two little dickie birds

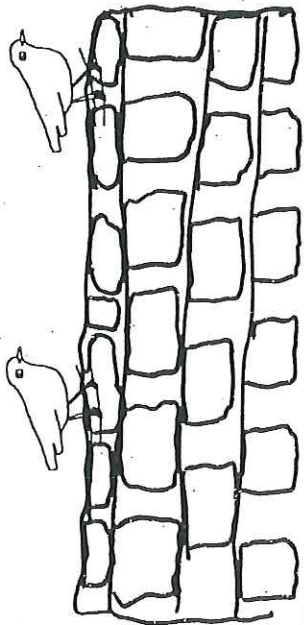

Rock a bye baby



Little boy blue

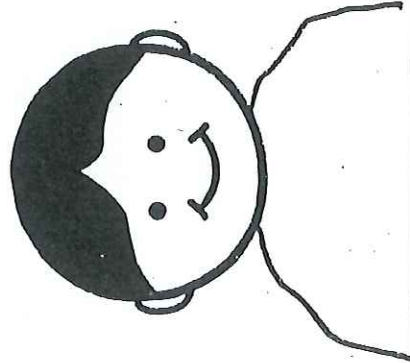

Head, shoulders, knees
and toes,
Knees and toes,
Head, shoulders, knees
and toes, knees and
toes,
And ears and eyes and
mouth and nose,
Head, shoulders, knees
and toes, knees and
toes.

Little boy blue,
Come blow up your horn,
The sheep's in the
meadow,
The cow's in the corn,
But where's the boy,
Who looks after the
sheep,
He's under the haystack
Fast asleep.

Tommy Thumb,
Tommy Thumb
Where are you?
Here I am, Here I am,
How do you do.
Peter Pointer
Toby Tall
Ruby Ring
Baby Small
Fingers all

Rock a bye baby on the
tree top,
When the wind blows,
The cradle will rock,
When the bough breaks,
The cradle will fall,
Down will come baby,
Cradle and all.

Two little dickie birds
Sitting on a wall.
One named Peter
One named Paul.
Fly away Peter
Fly away Paul.
Come back Peter
Come back Paul.

Wind the bobbin up,
Wind the bobbin up,
Pull, pull,
Clap, clap, clap.
Point to the ceiling,
Point to the floor,
Point to the window,
Point to the door.
Clap your hands
together 1, 2, 3,
Out your hands upon
your knees.

See-Saw Margery Daw

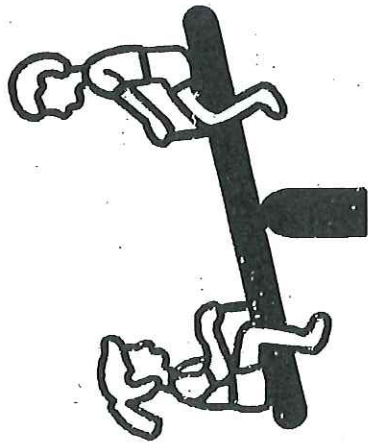

Yellow bird



1 2 3 4 5 fish



Pussy Cat, Pussy Cat

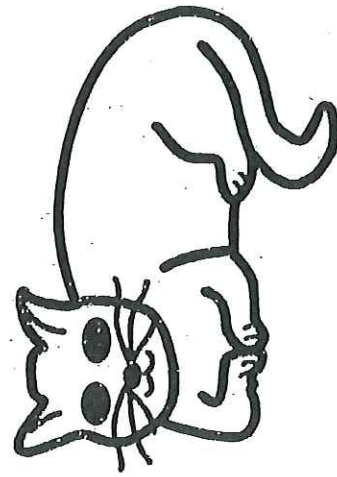

Jingle Bells

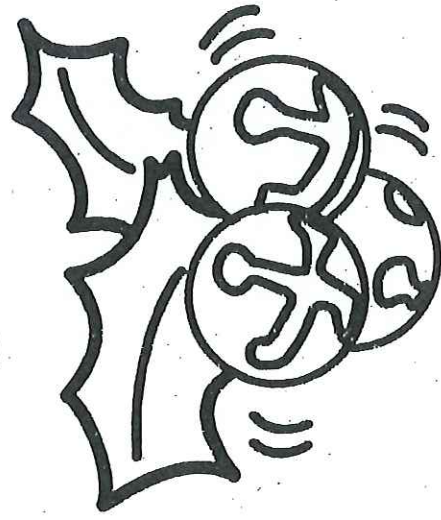

Away in a Manger

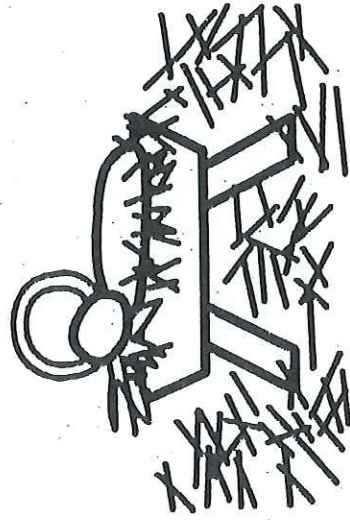

Away in a manger,
No crib for a bed,
The little Lord Jesus,
Lay down his sweet head.
The stars in the bright sky,
Look down where he lay,
The little Lord Jesus,
Asleep in the hay.

Yellow Bird way up high in
banana tree,
Yellow bird you sit all alone
like me,
Did your lady friend
Leave de nest again?
Dat is very sad
Make me feel so bad,
You can fly away
In the sky away
Your'e more lucky than me.

Jingle bells, Jingle bells,
Jingle all the way,
Oh what fun it is to ride on
a one horse open sleigh.
Jingle bells, jingle bells,
Jingle all the way,
Oh what fun it is to ride on
A one horse open sleigh.

Seesaw, Magery Daw,
Johnny shall have a new
master,
He shall have a penny a day
Because he can't work any
faster.

Pussy cat, pussy cat,
Where have you been?
I've been to London to look
at the Queen.
Pussy cat, pussy cat
What did you there?
I frightened a mouse
Right under the chair.

Two little dickie birds

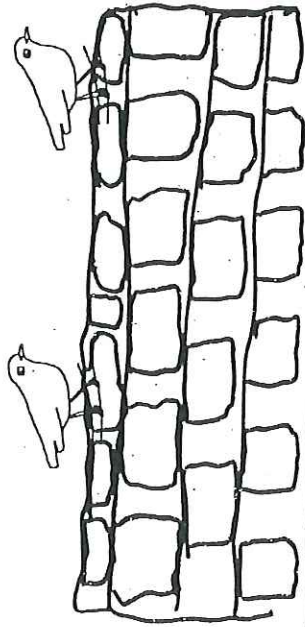

Tommy Thumb

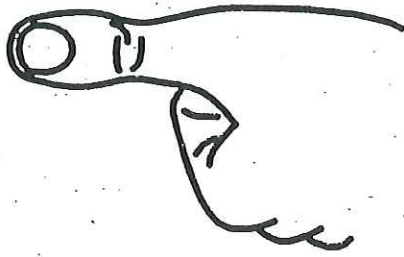

head, shoulders, knees and toes

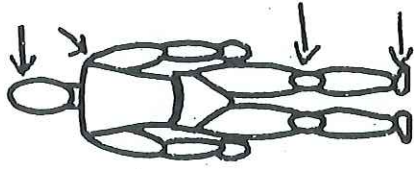

Wind the bobbin up

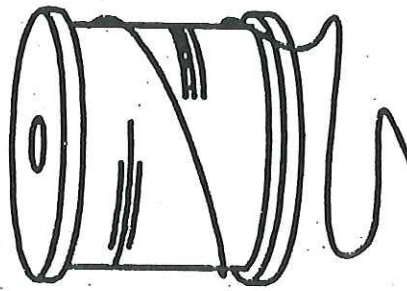

Rock a bye baby



Little boy blue

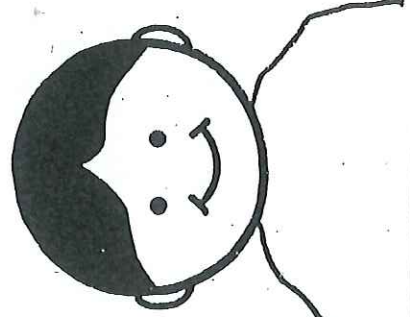

Head, shoulders, knees
and toes,
Knees and toes,
Head, shoulders, knees
and toes, knees and
toes,
And ears and eyes and
mouth and nose,
Head, shoulders, knees
and toes, knees and
toes.

Tommy Thumb,
Tommy Thumb
Where are you ?
Here I am, Here I am,
How do you do.
Peter Pointer
Toby Tall
Ruby Ring
Baby Small
Fingers all

Two little dickie birds
Sitting on a wall.
One named Peter
One named Paul.
Fly away Peter
Fly away Paul.
Come back Peter
Come back Paul.

Little boy blue,
Come blow up your horn,
The sheep's in the
meadow,
The cow's in the corn,
But where's the boy,
Who looks after the
sheep,
He's under the haystack
Fast asleep.

Rock a bye baby on the
tree top,
When the wind blows,
The cradle will rock,
When the bough breaks,
The cradle will fall,
Down will come baby,
Cradle and all.

Wind the bobbin up,
Wind the bobbin up,
Pull, pull,
Clap, clap, clap,
Point to the ceiling,
Point to the floor,
Point to the window,
Point to the door.
Clap your hands
together 1, 2, 3,
Out your hands upon
your knees.